



ΚΟΛΛΕΓΙΟ ΑΘΗΝΩΝ
Ελληνο-Αμερικανικό Εκπαιδευτικό Ίδρυμα
Νηπιαγωγείο • Δημοτικό • Γυμνάσιο • Λύκειο
ΚΟΛΛΕΓΙΟ ΑΘΗΝΩΝ • ΚΟΛΛΕΓΙΟ ΨΥΧΙΚΟΥ • ΝΗΠΙΑΓΩΓΕΙΟ Ι.Μ. ΚΑΡΡΑΣ

1925

Δημοτικό
Κολλεγίου Ψυχικού
Τάξη 1^η

Μαθαίνω τα γράμματα

1^ο τεύχος

Όνομα: _____







Ημερομηνία: _____

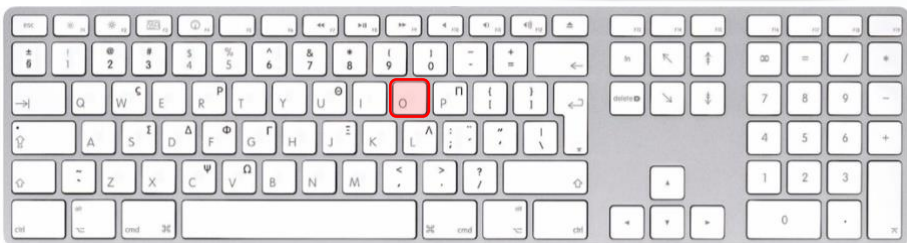
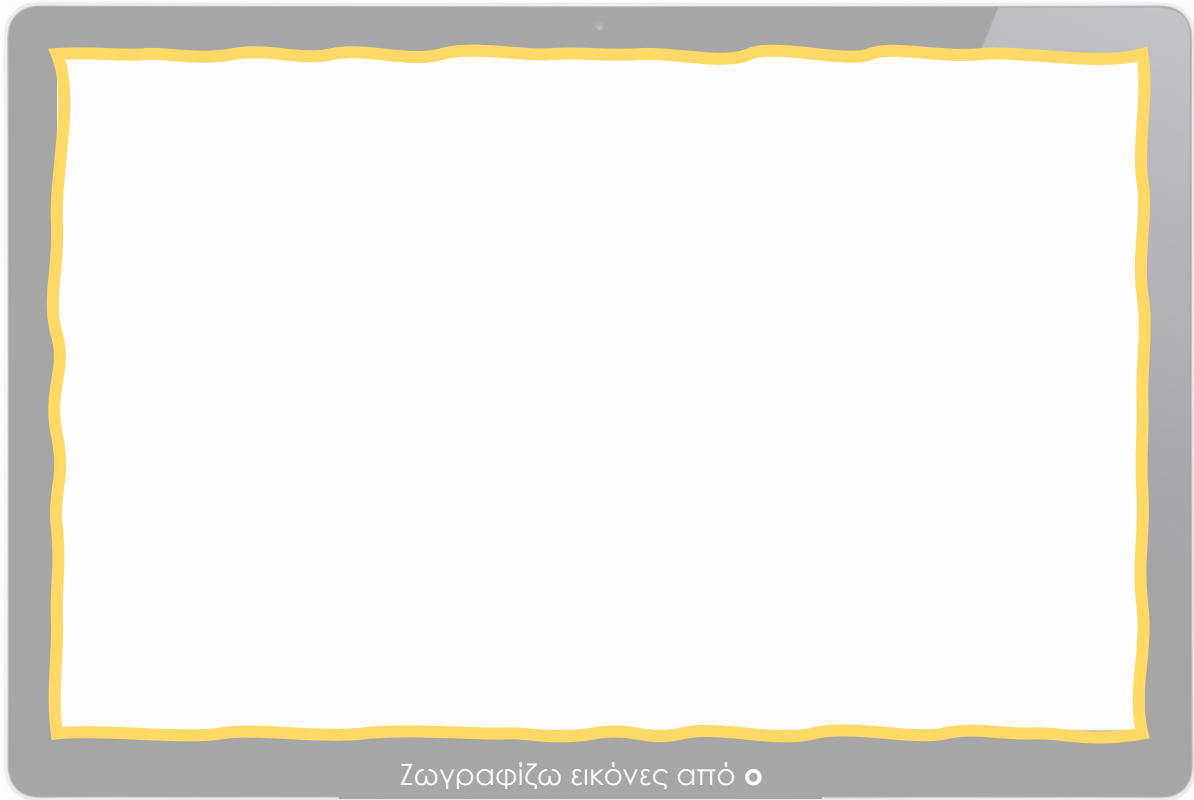
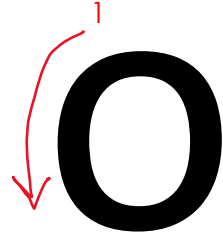
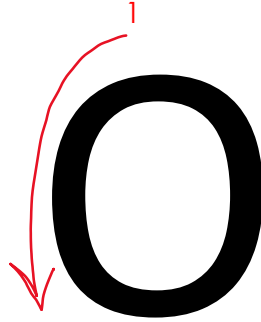

Ημερομηνία: _____

Ο ο Ο ο Ο ο

• • •

• • •

• • •



Όνομα •

Ημερομηνία: _____

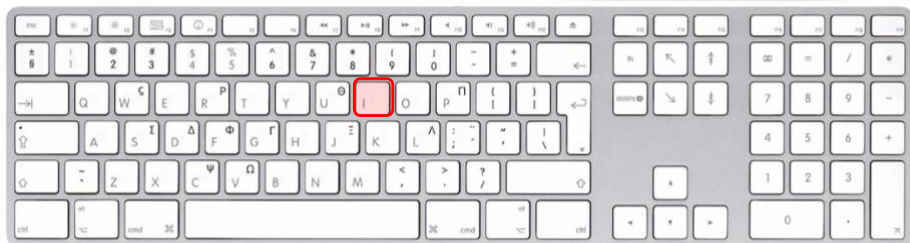
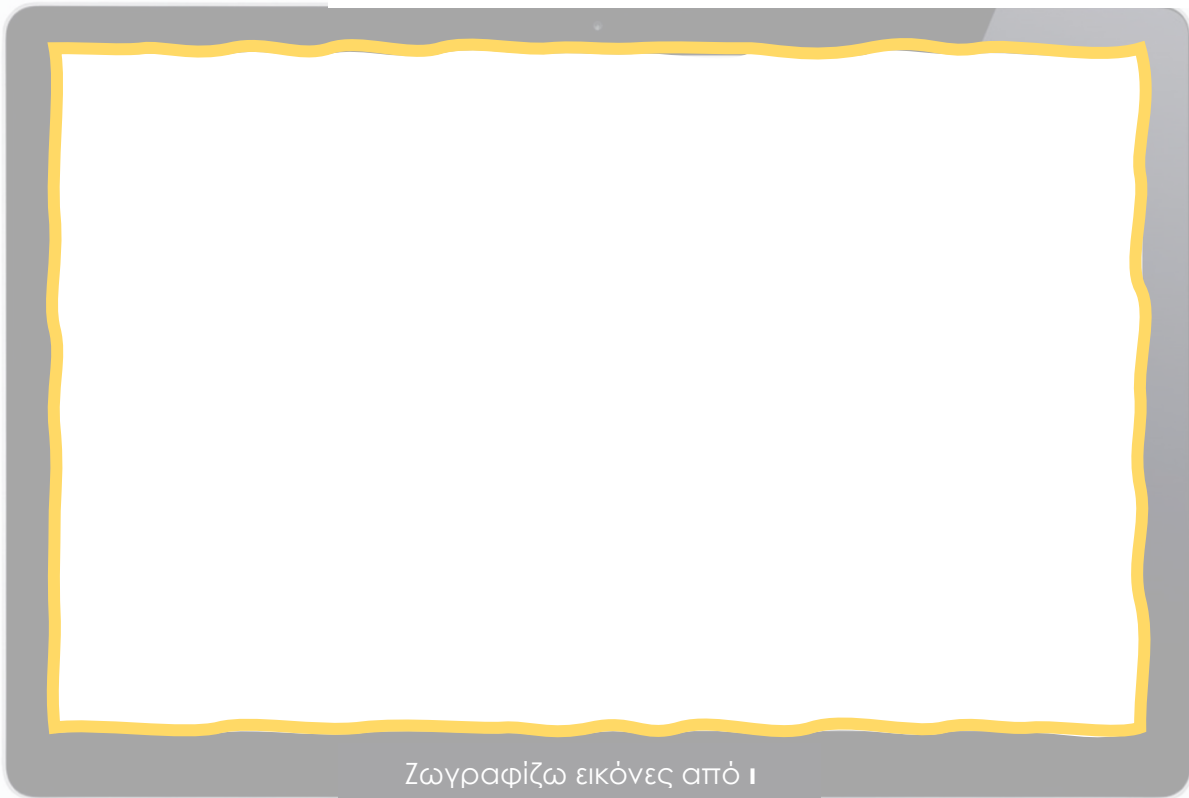
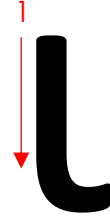
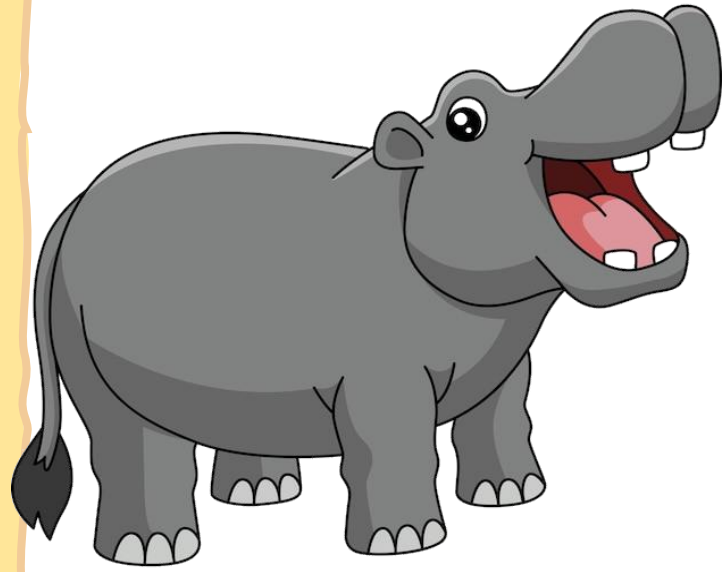



Ημερομηνία: _____

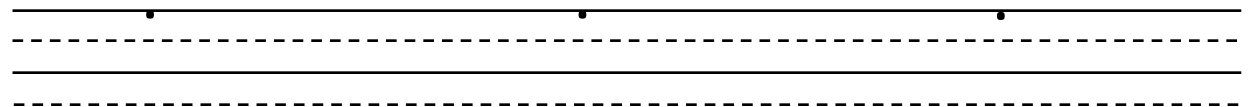
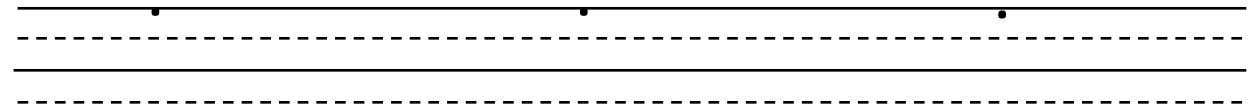
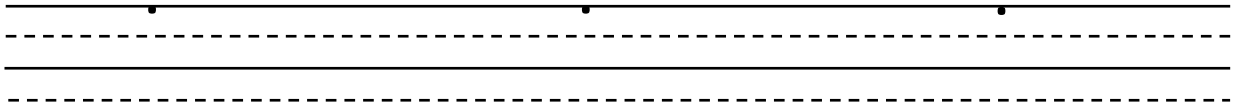
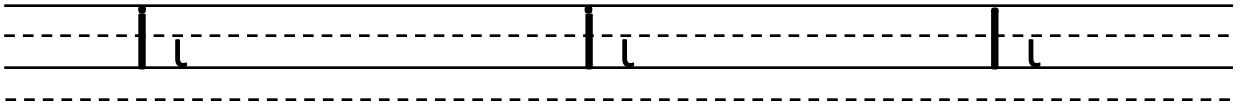

Όνομα _____

Ημερομηνία: _____

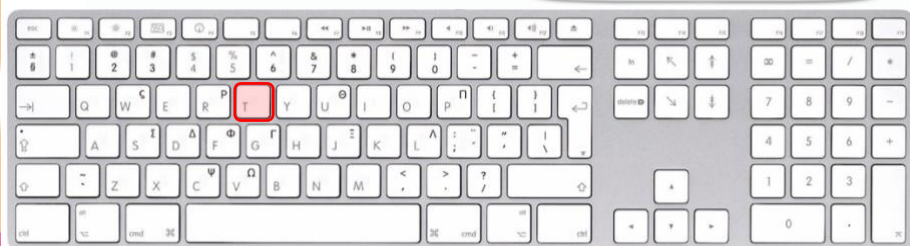
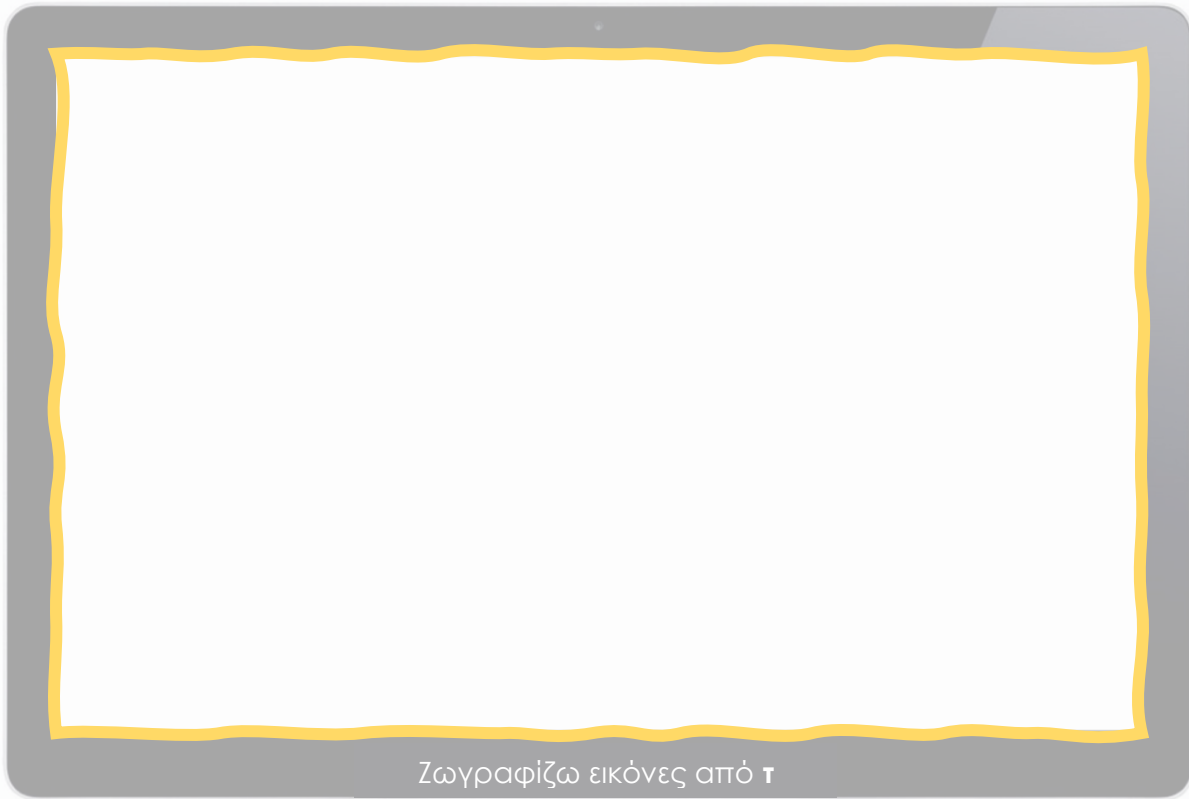
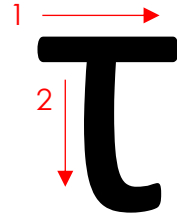
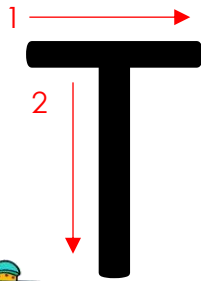
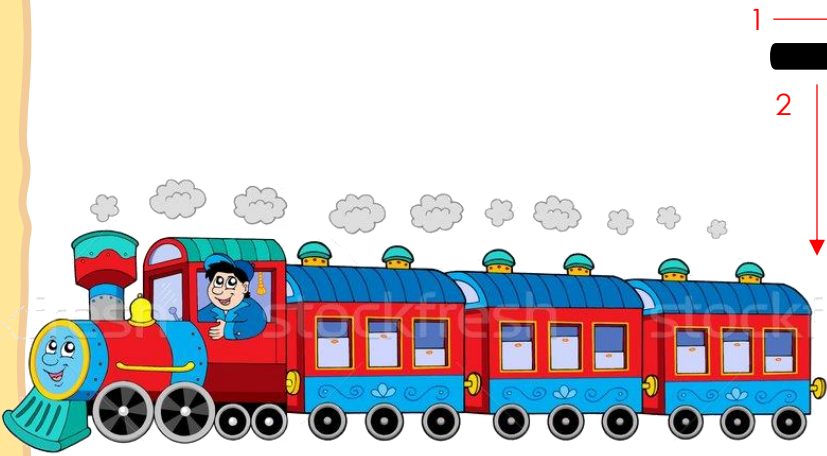

Ημερομηνία: _____

Τ τ Τ τ Τ τ

• • •

• • •

• • •

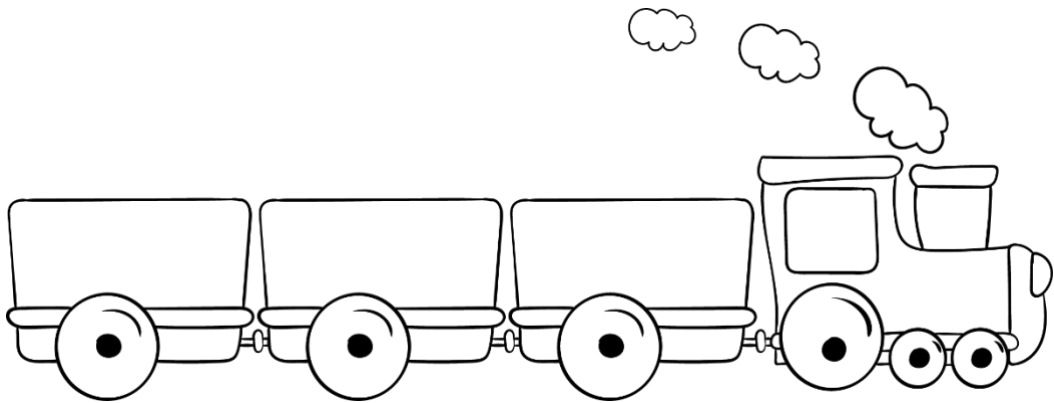

Όνομα _____



Ημερομηνία: _____

το τι

• •

• •

• •

Όνομα •

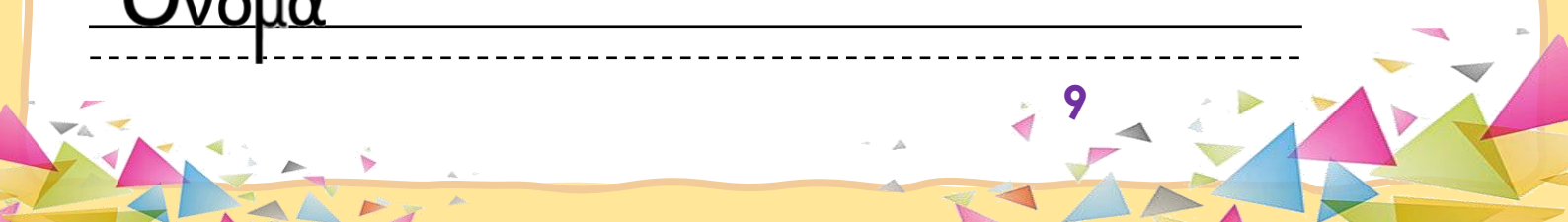

Ημερομηνία: _____



Όνομα _____

Ημερομηνία: _____

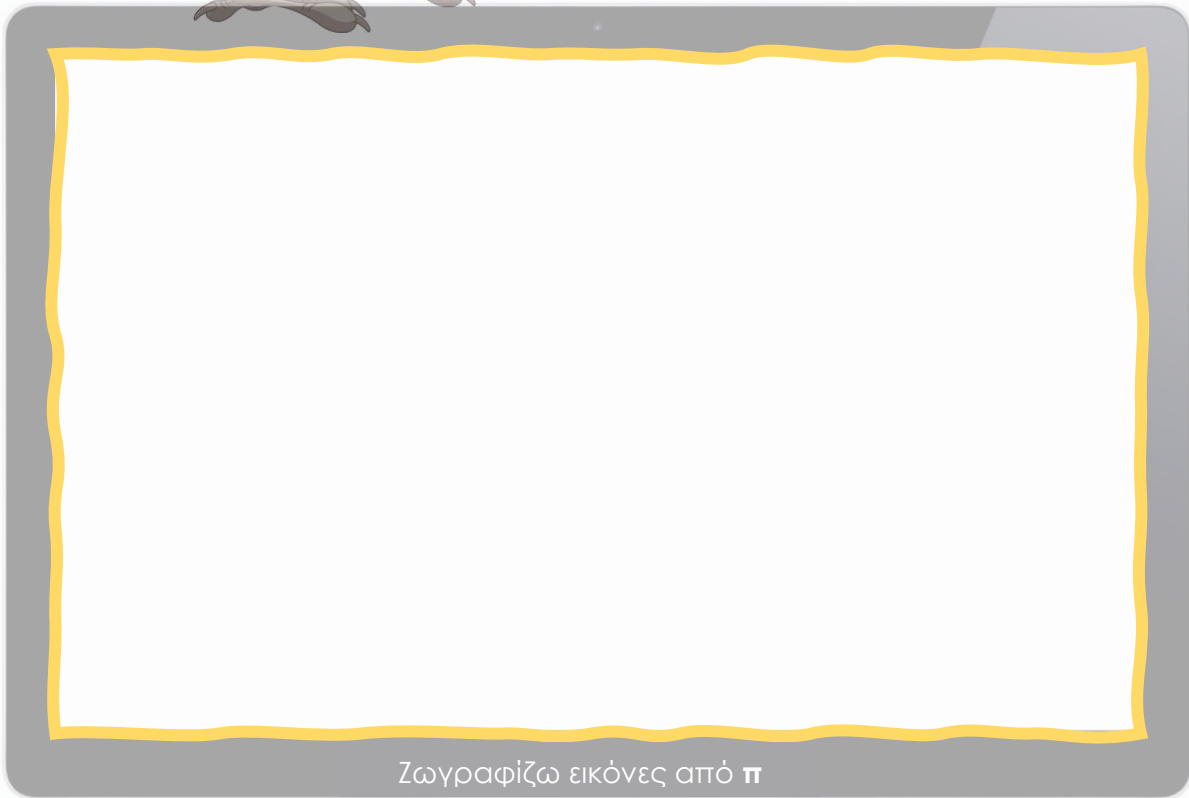
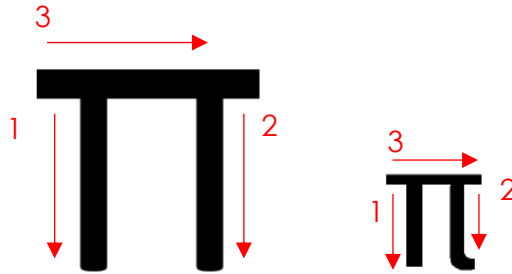

Ημερομηνία: _____

Π Π π Π Π π Π Π π

• • •

• • •

• • •



Όνομα •

Ημερομηνία: _____

τόπι

.

.



Όνομα

Ημερομηνία: _____



Όνομα _____

Ημερομηνία: _____

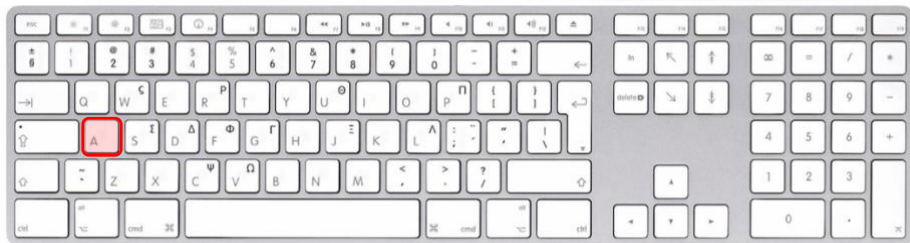
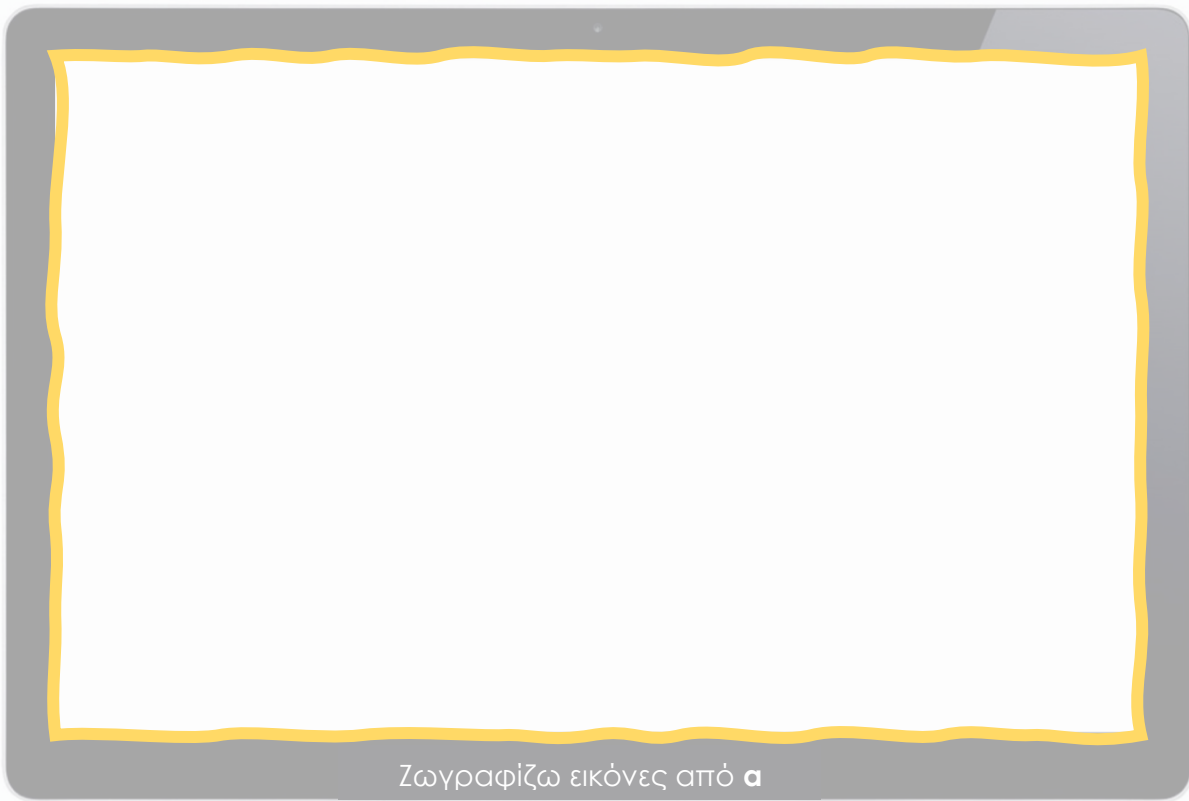
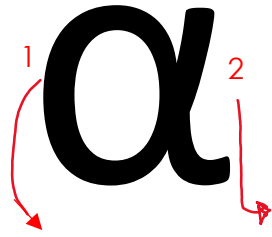
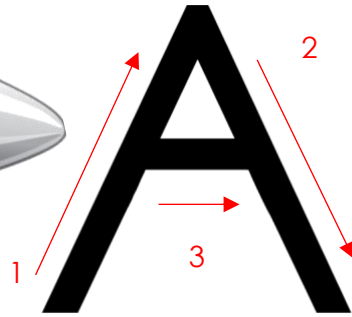

Ημερομηνία: _____

Α α Α α Α α

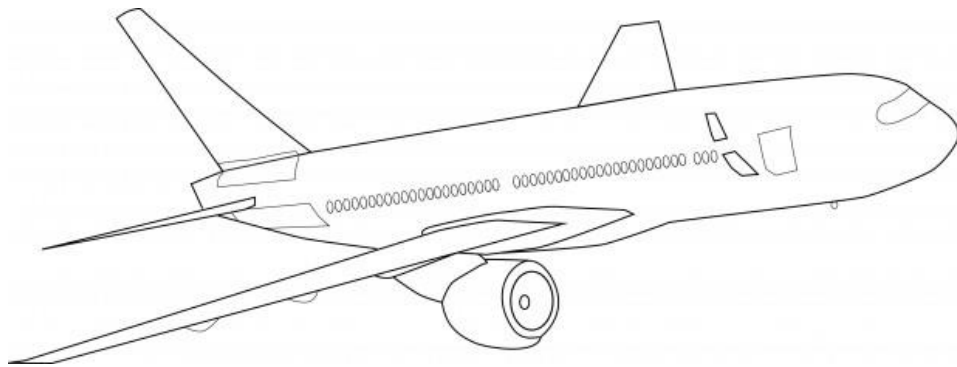

Όνομα _____

Ημερομηνία: _____

παπί

πίτα



Όνομα



Ημερομηνία: _____

Όνομα _____

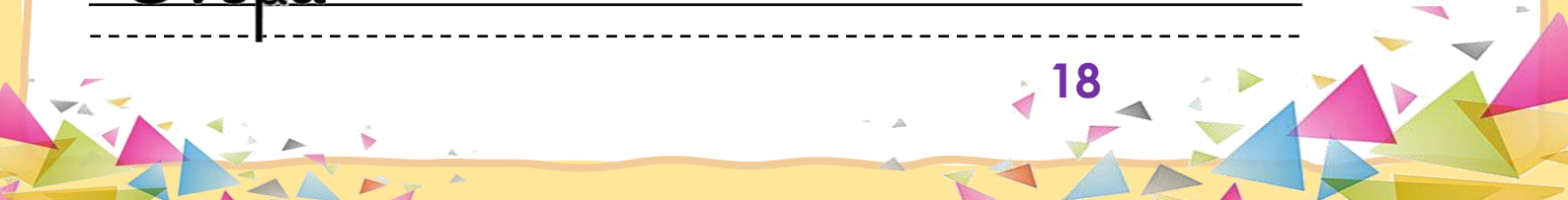

Ημερομηνία: _____

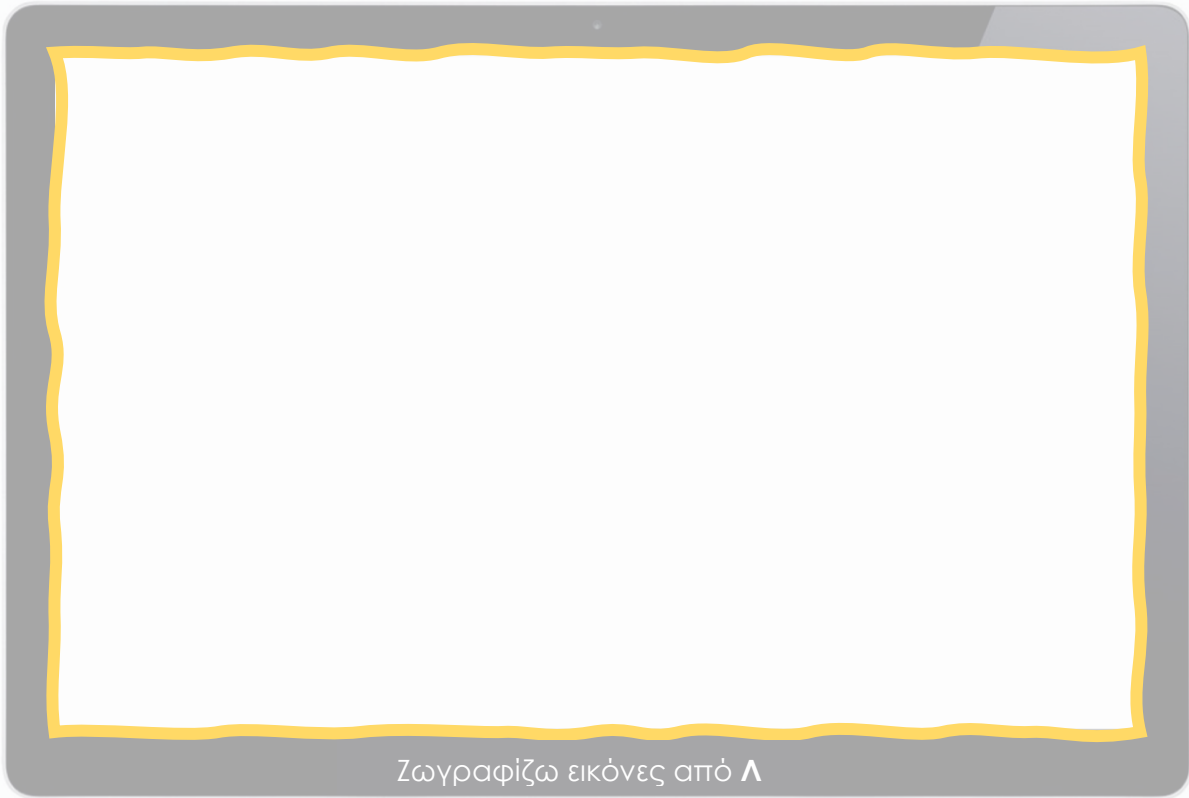
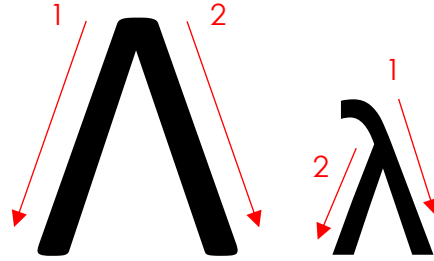
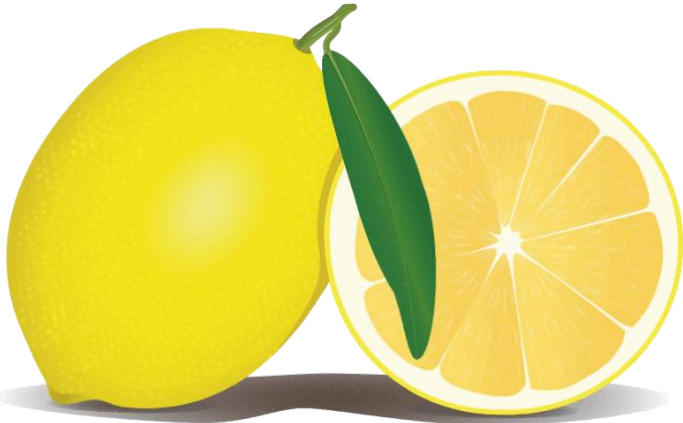

Ζωγραφίζω εικόνες από Λ

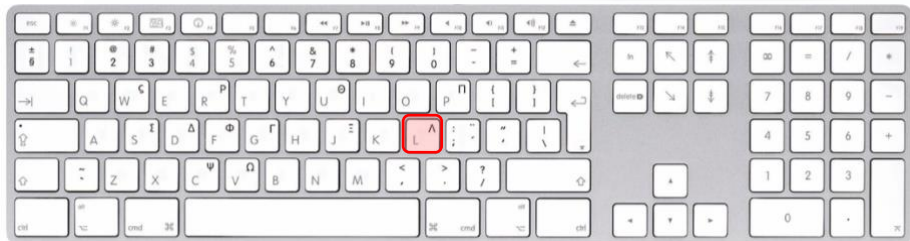



Ημερομηνία: _____

Α α Α α Α α

• • •

• • •

• • •

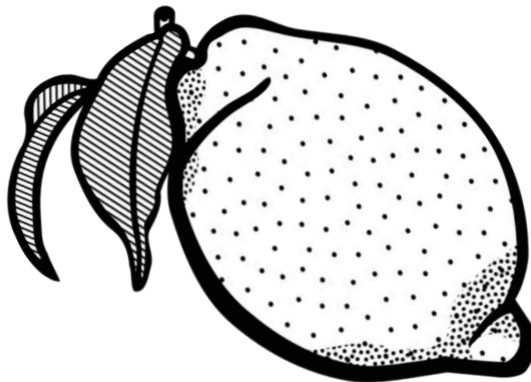

Όνομα •

Ημερομηνία: _____

πιπίλα



Όνομα _____

Ημερομηνία: _____



Όνομα _____

Ημερομηνία: _____

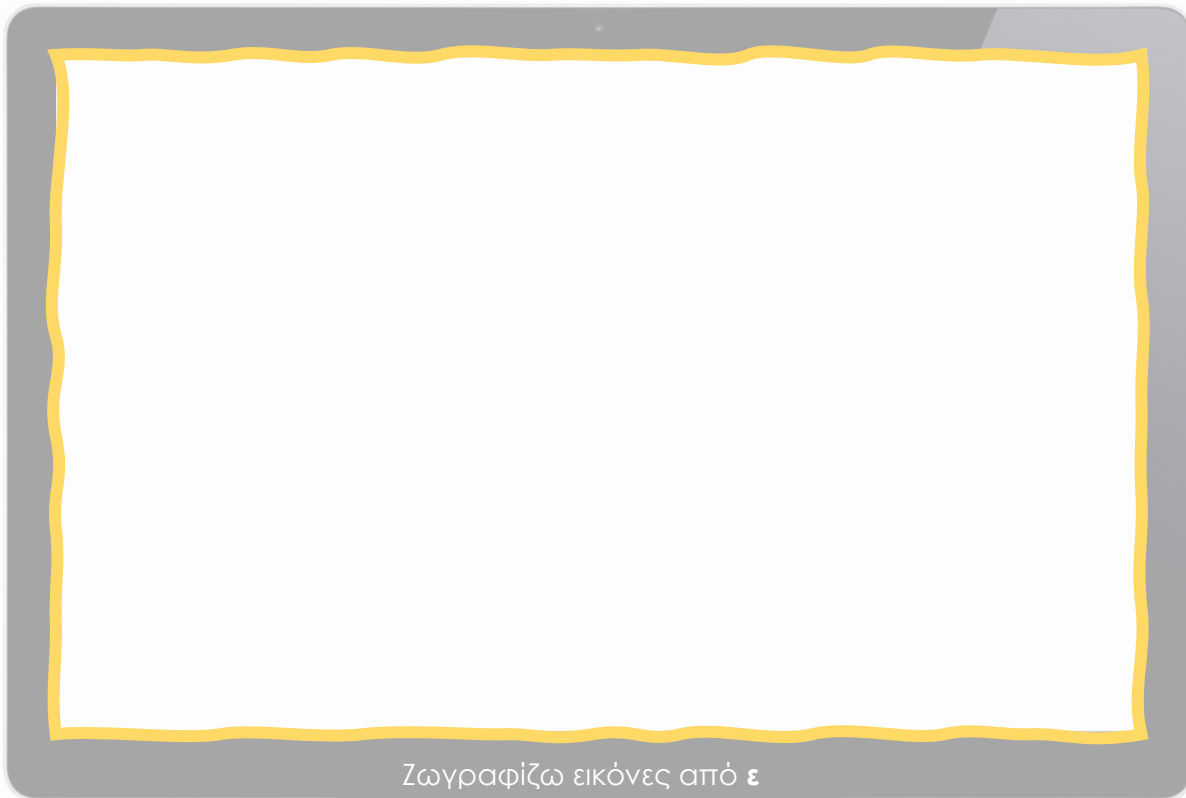
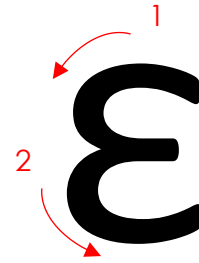
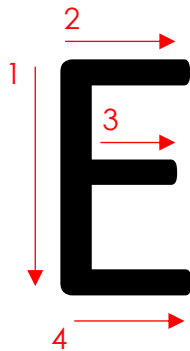
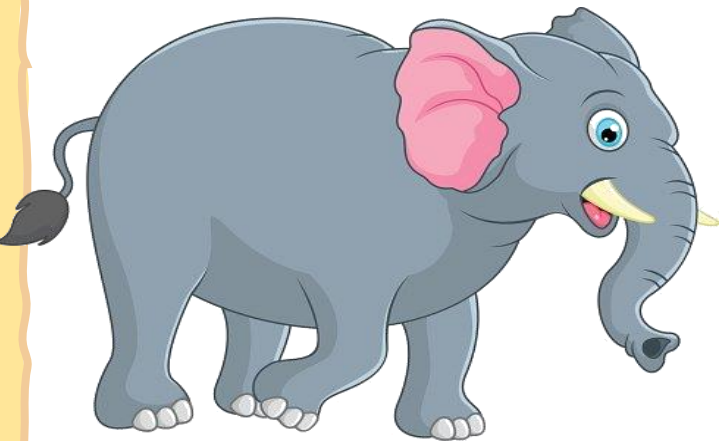

Ζωγραφίζω εικόνες από ε



Ημερομηνία: _____

E ε E ε E ε

• • •

• • •

• • •

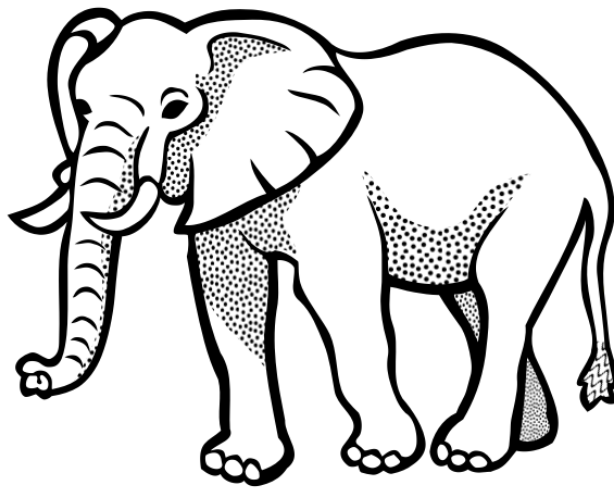

Όνομα •

Ημερομηνία: _____

το έλατο

•

•



Όνομα _____

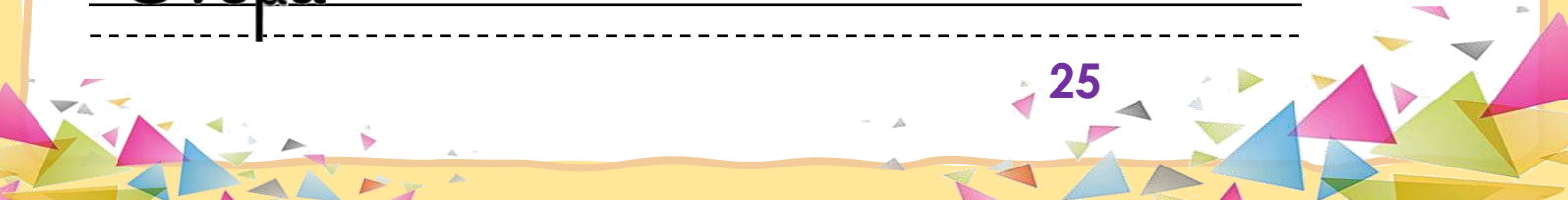

Ημερομηνία: _____

ΕΧΕΙ

έχει



Όνομα

Ημερομηνία: _____

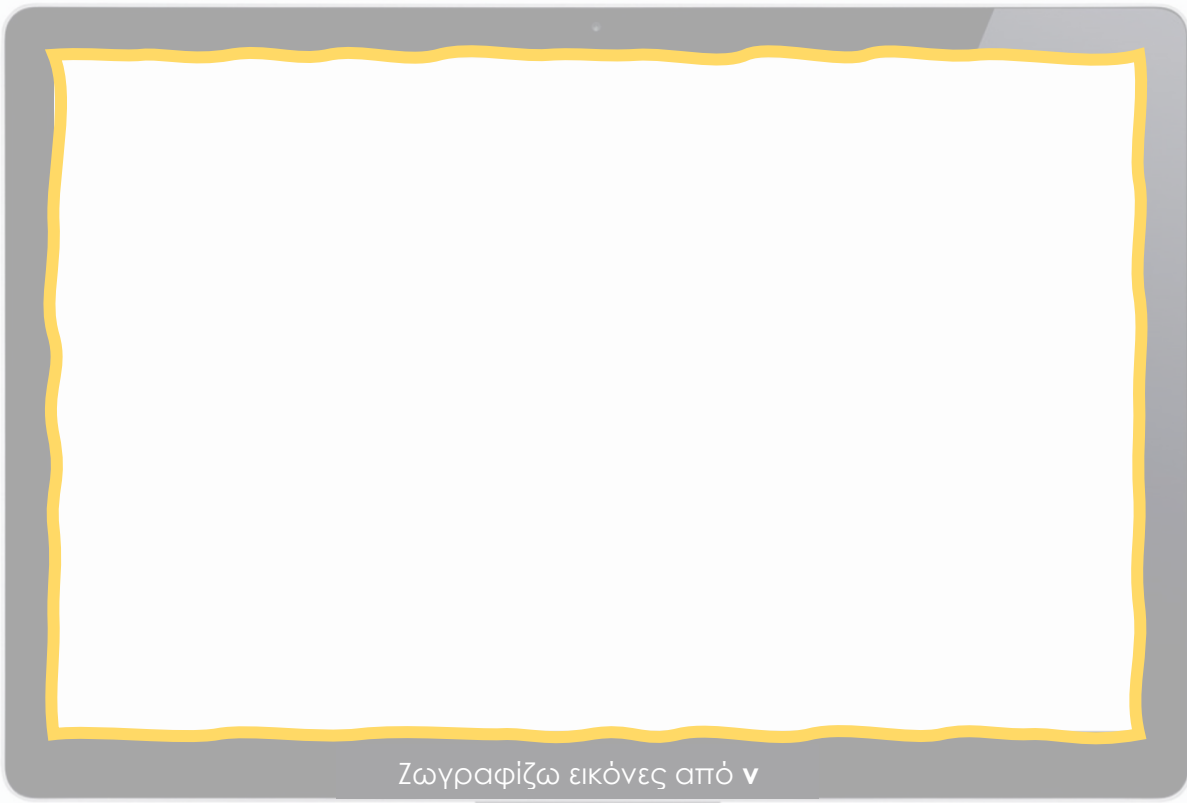
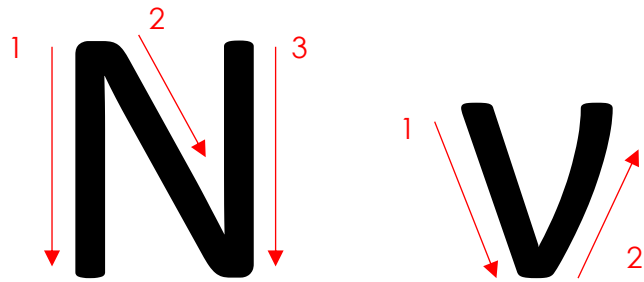

Ημερομηνία: _____

N n N n N n

• • •

• • •

• • •



Όνομα •

Ημερομηνία: _____

πατίλι ένα



Όνομα _____

Ημερομηνία: _____

Να ένα παλάτι.



Όνομα _____

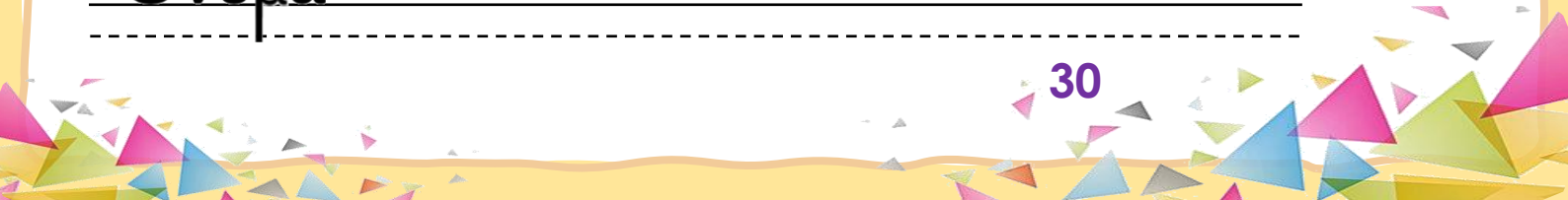

Ημερομηνία: _____

ΕΙΝΑΙ **είναι**



Όνομα _____

Ημερομηνία: _____



Όνομα _____

Ημερομηνία: _____

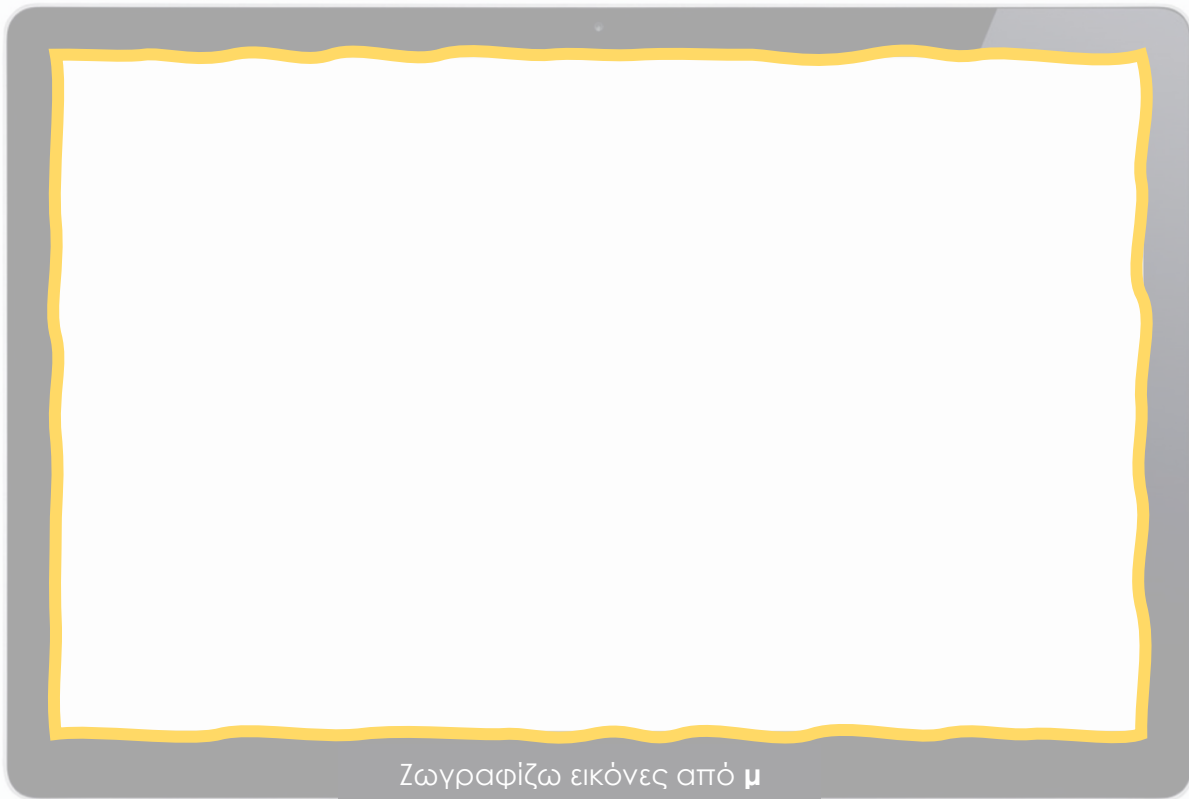
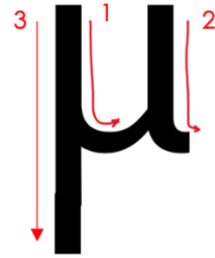
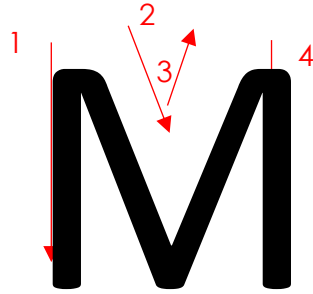
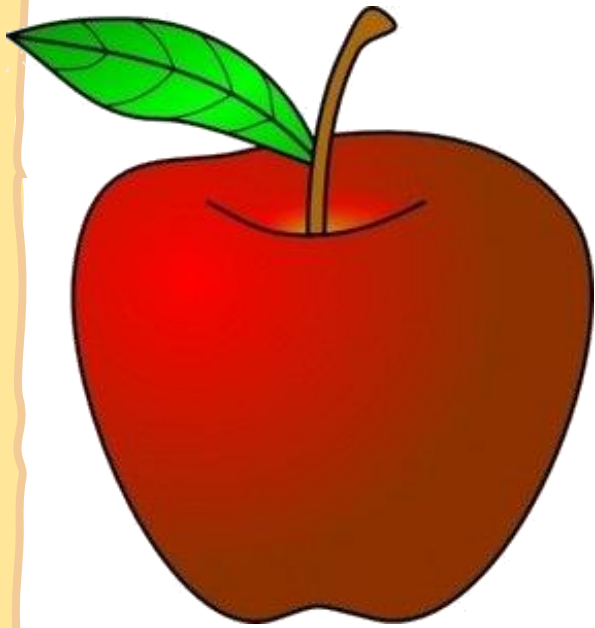

Ζωγραφίζω εικόνες από μ

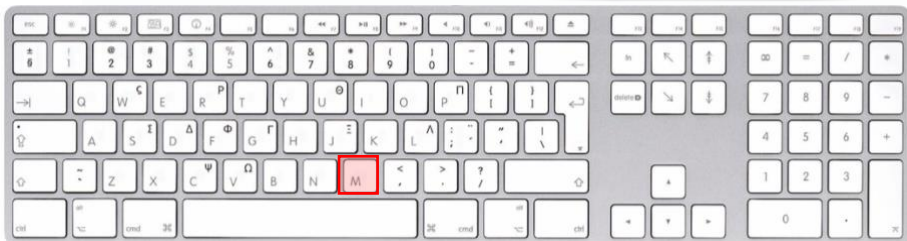

Ημερομηνία: _____

Μ μ Μ μ Μ μ

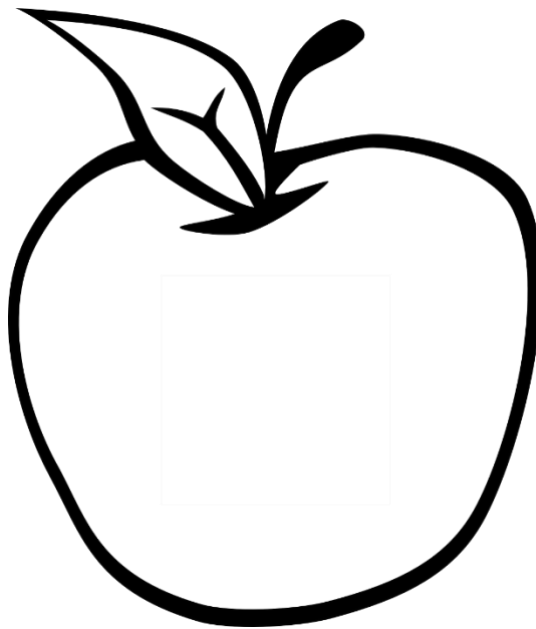

Όνομα _____

Ημερομηνία: _____

μάμα μέλι

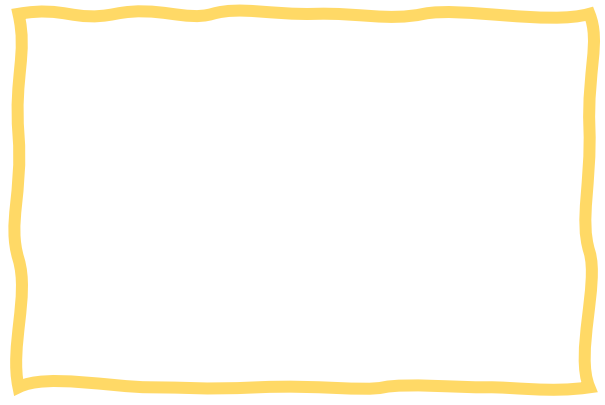
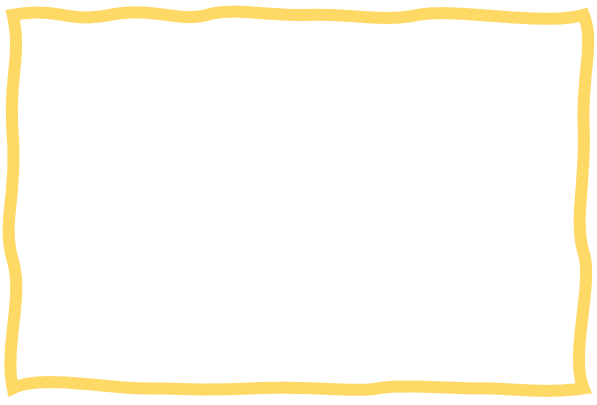

μάτι λεμόνι



Όνομα _____

Ημερομηνία: _____

Μελένε



Όνομα _____

Ημερομηνία: _____

Γράφω δεξιά τις λέξεις με κεφαλαία γράμματα:



νότα →

ποτέ →

λίμα →

Όνομα

Ημερομηνία: _____

Γράφω δεξιά τις λέξεις με πεζά γράμματα:



ΠΕΝΑ → .

ΜΑΤΙ → .

ΕΛΛΑ → .

Όνομα .

